



- Optimal three stage charging
- State of charge / service LEDs
- Low standby battery drain
- Customizable charge algorithm
- Optional control / status signals
- Optional temp compensation
- Vibration resistant
- Reverse polarity protected
- Over temperature protected
- Over current / voltage protected
- Waterproof / hermetically sealed
- UL/CSA 1236 certified
- Two year warranty

Description

The CK150-3 is a rugged, waterproof and sophisticated three stage lead-acid battery charger. With a wide operating temperature range (-20C to 50C) and UL/CSA1236 certification, this product is especially suited for high end industrial applications. The CK150-3 is factory programmable to accommodate several charging algorithms and an LED display to indicate status. The charger is controlled by an embedded

microcontroller that contains software developed by and proprietary to ChargeTek. The CK150-3 precisely controls charging voltage and current to insure a complete recharge every time. The charger may be left connected indefinitely to the battery, maintaining full charge at all times. The CK150-3 can be purchased with either ring terminals only or an interchangeable ring terminal / alligator clip termination.

Charging specifications

PARAMETER	DESCRIPTION / CONDITIONS	MIN	NOM	MAX	UNITS
V_{FSTERM}	Fast charge termination voltage, 25C	14.4	14.6	14.8	VDC
V_{FL}	Float voltage, $I_{OUT} < 1.0 A$, 25 C	13.4	13.6	13.7	VDC
I_{FS}	Fast charge current, $V_{BATTERY} = 24V$	1.5		2.0	Amps
I_{ABTERM}	Absorption mode charge termination current, transition from fast to absorption	0.65		0.85	Amps
I_{FLTERM}	Float charge termination current	0.30		0.40	Amps
I_{SBY}	Standby current, AC off			0.5	ma

Charging algorithm: Supplies constant current to battery until V_{FSTERM} transition to absorption mode follows and regulates battery voltage at V_{FSTERM} until current decreases to I_{ABTERM} . Float mode follows and regulates battery voltage at V_{FL} .

Three stage charging curve

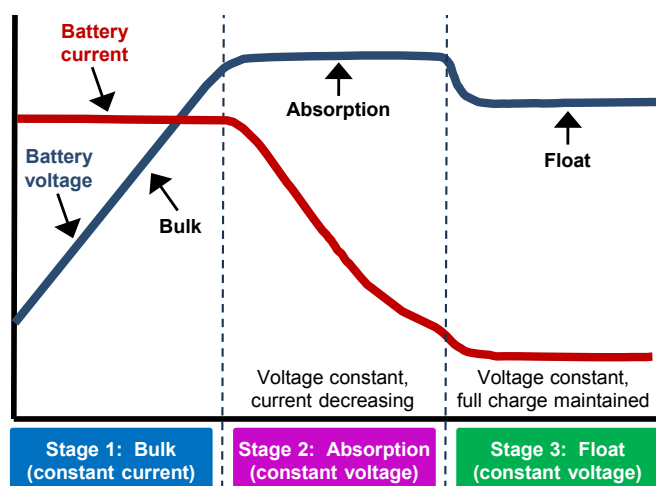

CK150-3 Datasheet

Input specifications

PARAMETER	DESCRIPTION / CONDITIONS	MIN	NOM	MAX	UNITS
AC voltage	47 - 63Hz	180	220	250	VAC
Input current	90VAC, 15VDC output		0.40		Amps

Environmental specifications

PARAMETER	DESCRIPTION / CONDITIONS
Storage temperature	-40°C - 80°C
Operating temperature	-20°C - 50°C
Relative humidity	0 - 95% relative humidity (non-condensing)
Input to output / chassis voltage isolation	2KV (leakage current less than 1mA)
Output to chassis voltage isolation	50V (can be increased / consult factory)

LED indicators

PARAMETER	DESCRIPTION	RED	RED / GREEN	GREEN
Charging mode	Indicates state of charge	Bulk	Flashing	Float
Service indicator	Indicates a charger failure	On		

Outline and mounting

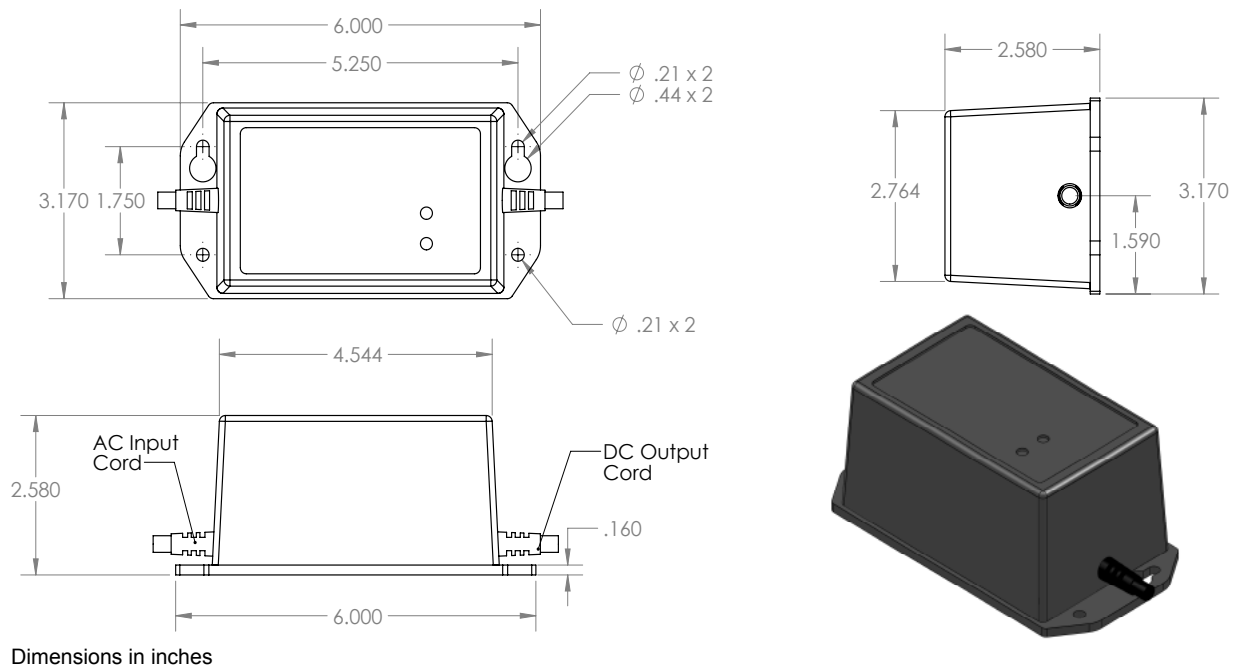

NOTE: Chargetek products are not authorized for use as components in life support systems, hazardous environments, nuclear control systems or other similar applications without the express written consent of the President of Chargetek, Inc. The appearance of products, including safety agency certifications pictured on labels, may change depending on the date manufactured. Specifications are subject to change without notice.